



TO-92 Plastic-Encapsulate Transistors

2N4401 TRANSISTOR (NPN)

FEATURES

Power dissipation

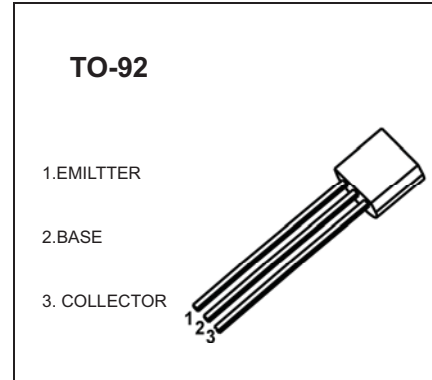

MARKING

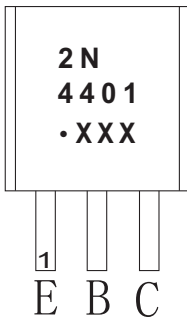

2N4401=Device code
 Solid dot=Green molding compound device,
 if none,the normal device
 XXX=Code

Equivalent Circuit

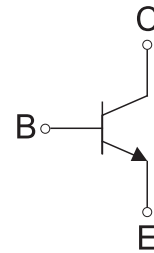

ORDERING INFORMATION

Part Number	Package	Packing Method	Pack Quantity
2N4401	TO-92	Bulk	1000pcs/Bag
2N4401-TA	TO-92	Tape	2000pcs/Box

MAXIMUM RATINGS (T_a=25°C unless otherwise noted)

Symbol	Parameter	Value	Unit
V _{CB0}	Collector-Base Voltage	60	V
V _{CE0}	Collector-Emitter Voltage	40	V
V _{EB0}	Emitter-Base Voltage	6	V
I _C	Collector Current -Continuous	600	mA
P _C	Collector Power dissipation	0.625	W
T _J , T _{stg}	Operation Junction and Storage Temperature Range	-55 ~ +150	°C
R _{θJA}	Thermal Resistance, junction to Ambient	357	°C/mW

ELECTRICAL CHARACTERISTICS

$T_a=25^\circ\text{C}$ unless otherwise specified

Parameter	Symbol	Test conditions	Min	Max	Unit
Collector-base breakdown voltage	$V_{(BR)CBO}$	$I_C=100\mu\text{A}$, $I_E=0$	60		V
Collector-emitter breakdown voltage	$V_{(BR)CEO}$	$I_C=1\text{mA}$, $I_B=0$	40		V
Emitter-base breakdown voltage	$V_{(BR)EBO}$	$I_E=100\mu\text{A}$, $I_C=0$	6		V
Collector cut-off current	I_{CBO}	$V_{CB}=35\text{V}$, $I_E=0$		0.1	μA
Emitter cut-off current	I_{EBO}	$V_{EB}=5\text{V}$, $I_C=0$		0.1	μA
DC current gain	$h_{FE(1)}$	$V_{CE}=1\text{V}$, $I_C=0.1\text{mA}$	20		
	$h_{FE(2)}$	$V_{CE}=1\text{V}$, $I_C=1\text{mA}$	40		
	$h_{FE(3)}$	$V_{CE}=1\text{V}$, $I_C=10\text{mA}$	80		
	$h_{FE(4)}$	$V_{CE}=1\text{V}$, $I_C=150\text{mA}$	100	300	
	$h_{FE(5)}$	$V_{CE}=2\text{V}$, $I_C=500\text{mA}$	40		
Collector-emitter saturation voltage	$V_{CE(sat)1}$	$I_C=150\text{mA}$, $I_B=15\text{mA}$		0.4	V
	$V_{CE(sat)2}$	$I_C=500\text{mA}$, $I_B=50\text{mA}$		0.75	V
Base-emitter saturation voltage	$V_{BE(sat)1}$	$I_C=150\text{mA}$, $I_B=15\text{mA}$		0.95	V
	$V_{BE(sat)2}$	$I_C=500\text{mA}$, $I_B=50\text{mA}$		1.2	V
Transition frequency	f_T	$V_{CE}=10\text{V}$, $I_C=20\text{mA}$, $f=100\text{MHz}$	250		MHz
Output Capacitance	C_{ob}	$V_{CB}=10\text{V}$, $I_E=0$, $f=100\text{KHz}$		6.5	pF
Delay time	t_d	$V_{CC}=30\text{V}$, $V_{BE(OFF)}=2\text{V}$		15	ns
Rise time	t_r		$I_C=150\text{mA}$, $I_{B1}=15\text{mA}$		20
Storage time	t_s	$V_{CC}=30\text{V}$, $I_C=150\text{mA}$		225	ns
Fall time	t_f		$I_{B1}=-I_{B2}=15\text{mA}$		30

Typical Characteristics

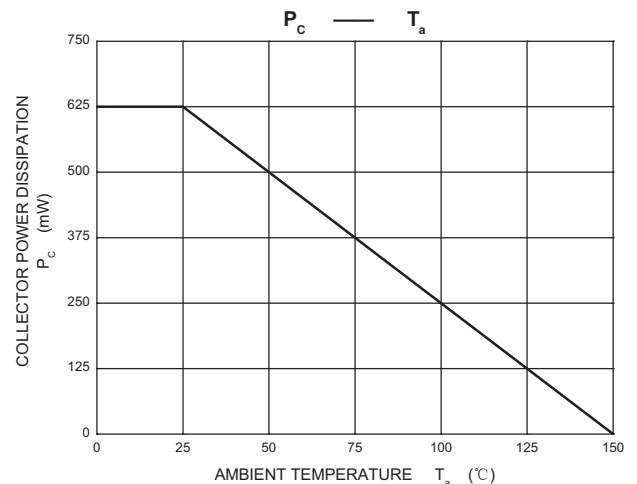
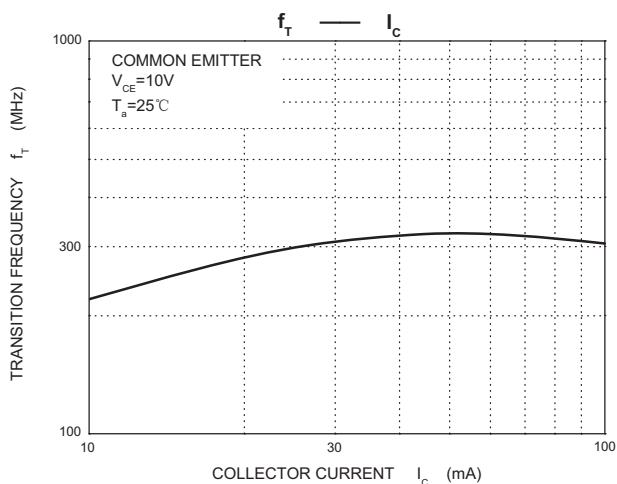
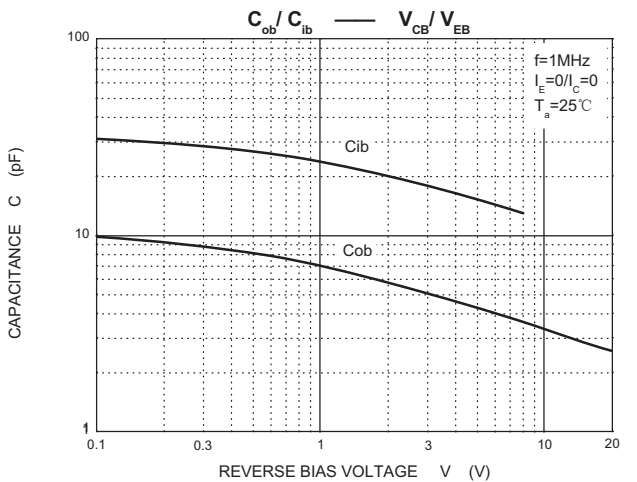
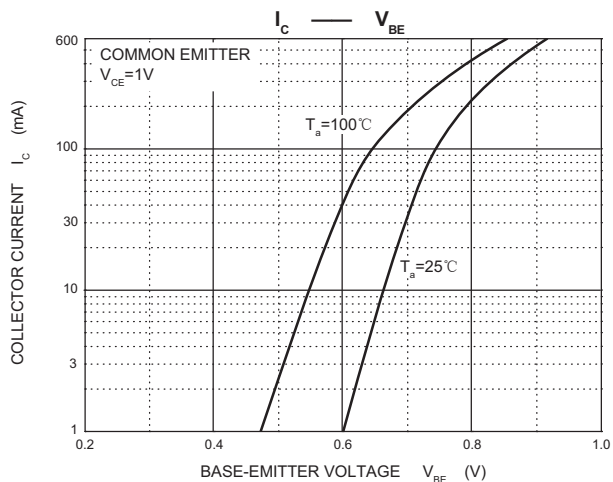
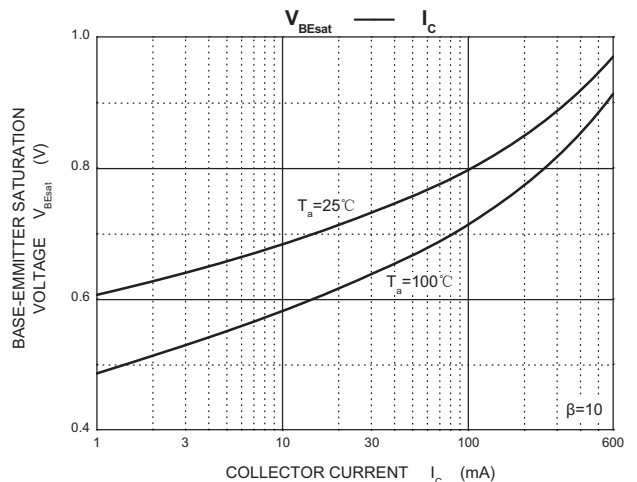
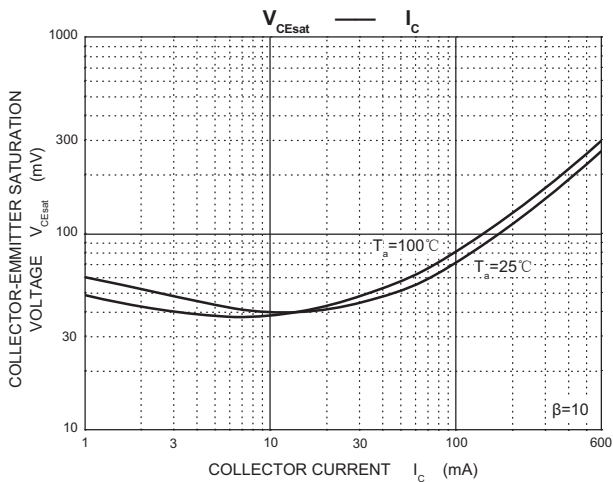
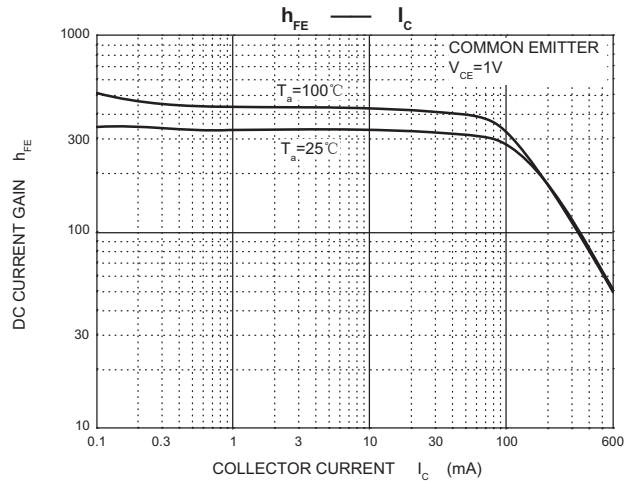
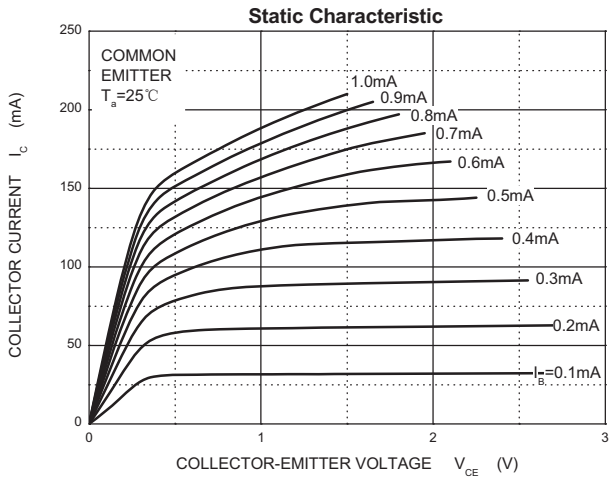

TO-92 Package Outline Dimensions

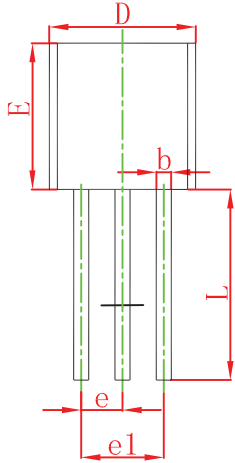
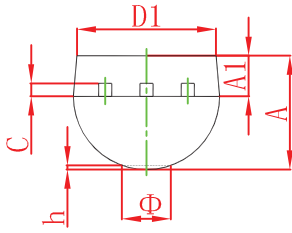

Symbol	Dimensions In Millimeters		Dimensions In Inches	
	Min	Max	Min	Max
A	3.300	3.700	0.130	0.146
A1	1.100	1.400	0.043	0.055
b	0.380	0.550	0.015	0.022
c	0.360	0.510	0.014	0.020
D	4.300	4.700	0.169	0.185
D1	3.430		0.135	
E	4.300	4.700	0.169	0.185
e	1.270 TYP		0.050 TYP	
e1	2.440	2.640	0.096	0.104
L	14.100	14.500	0.555	0.571
Φ		1.600		0.063
h	0.000	0.380	0.000	0.015

TO-92 Suggested Pad Layout

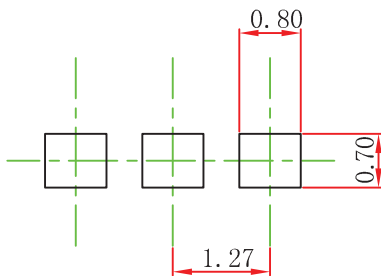

Note:

1. Controlling dimension: in millimeters.
2. General tolerance: $\pm 0.05\text{mm}$.
3. The pad layout is for reference purposes only.

NOTICE

JSCJ reserves the right to make modifications, enhancements, improvements, corrections or other changes without further notice to any product herein. JSCJ does not assume any liability arising out of the application or use of any product described herein.

TO-92 Tape and Reel

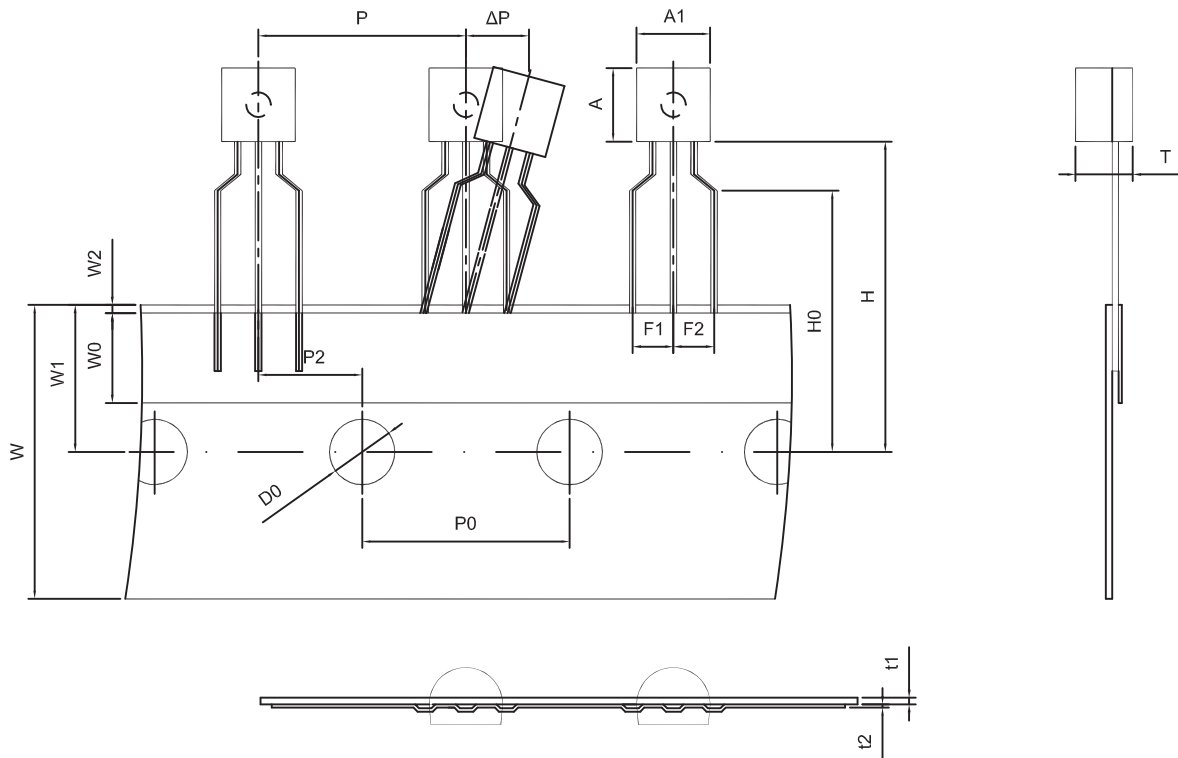

Dimensions are in millimeter

A1	A	T	P	P0	P2	F1	F2	W
4.5	4.5	3.5	12.7	12.7	6.35	2.5	2.5	18.0
W0	W1	W2	H	H0	D0	t1	t2	ΔP
6.0	9.0	1.0 MAX.	19.0	16.0	4.0	0.4	0.2	0

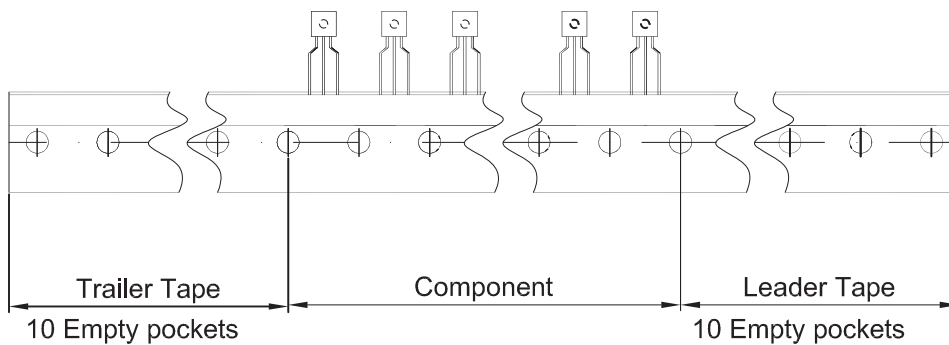

Package	Box	Box Size(mm)	Carton	Carton Size(mm)
TO-92	2000 pcs	333×162×43	20,000 pcs	350×340×250